

Before you begin

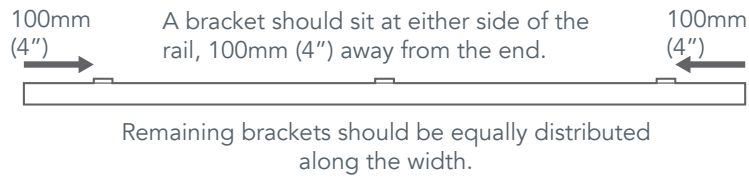

If you are using top-fix brackets, place them so that the back of the rear bracket is at least 75mm away from the window frame. There should then be a space of at least 45mm between the rear bracket and the front bracket. This ensures that there's enough space for the fabric to fold on both pairs of curtains.

Installing the brackets - Face-Fix

1

Start by ensuring that the clips are spaced correctly. On the front clip, line up the front screw with the front of the foremost adjustment slot. On the rear clip, line up the back screw with the back of the rearmost adjustment slot (as shown, right).

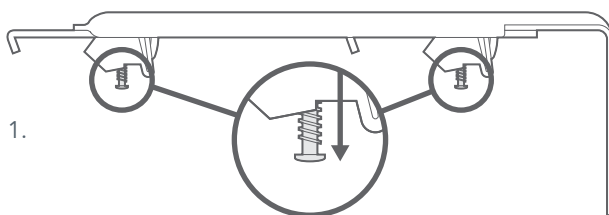
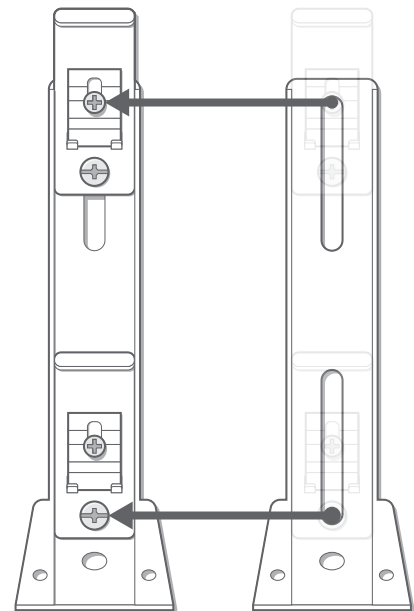
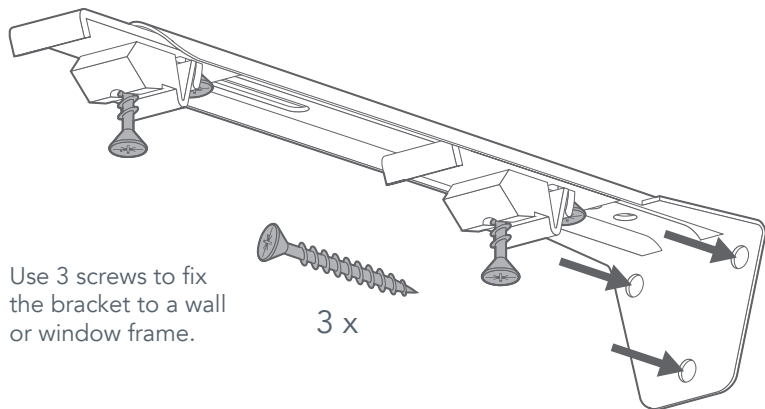

Loosen the front screw on each of the clips.

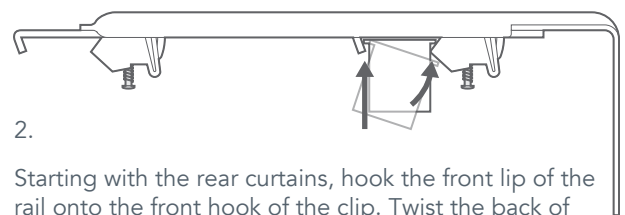

Starting with the rear curtains, hook the front lip of the rail onto the front hook of the clip. Twist the back of the rail up until it clicks into place.

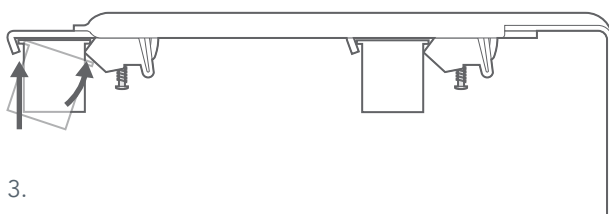

Now do the same for the front pair of curtains.

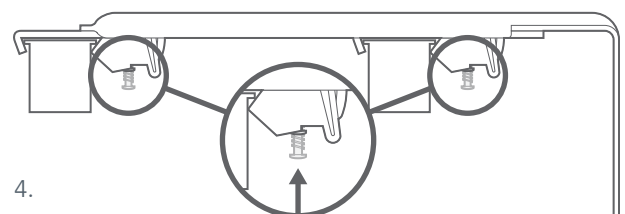

Tighten the locking screws you loosened to begin with, to lock the rails into the brackets.

Installing the brackets - Top-Fix

You will be using the locking screw for each bracket to mount it up against a ceiling or lintel. Ensure that there is a space of at least 45mm between the two brackets.

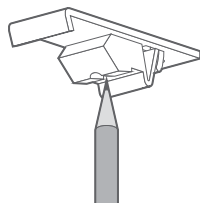
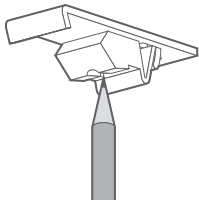
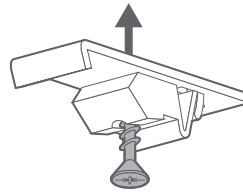
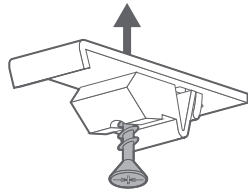

Start by marking out where each bracket will go. Remove the locking screw from each bracket, then hold each bracket in its desired position, then use a pencil to mark where the screw will go.

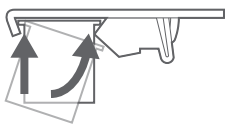

Attach the brackets onto both rails. To do that, rest the front lip of the headrail against the front hook of the bracket. Then twist the back of the rail upwards until it snaps into place.

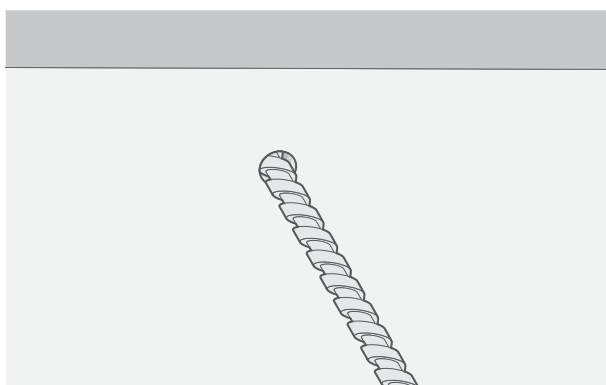

Drill holes into the lintel where you marked out the holes for your brackets, and insert a rawl plug into each hole.

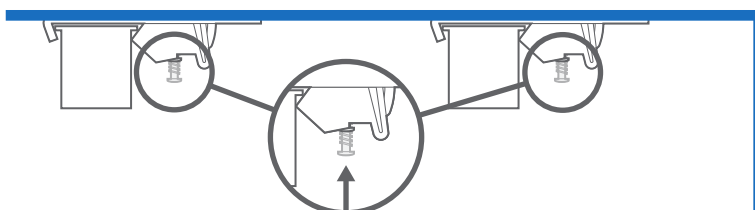

Line up the locking screws of the brackets with the holes you've drilled, then tighten the locking screw in each bracket to secure the rails in place.

Hanging your curtains

2

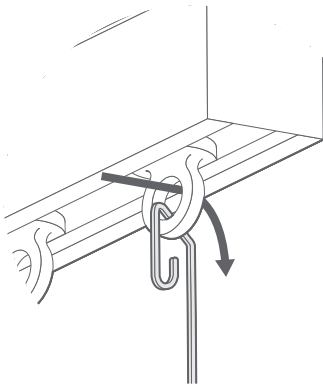

Insert the hooks into the plastic eyelets in the headrail.

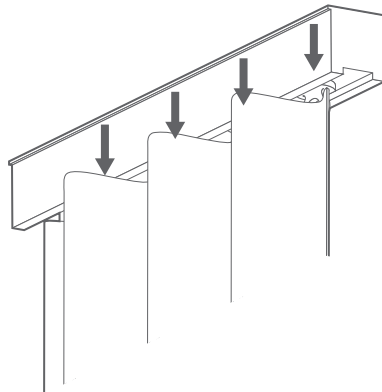

Continue until all of the hooks are inserted, then enjoy your beautiful new curtains!

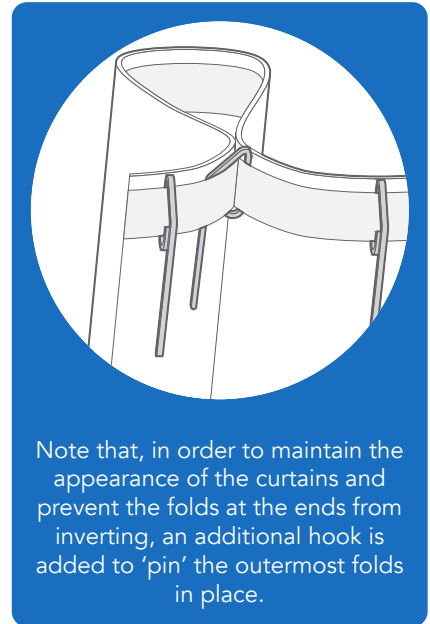

Note that, in order to maintain the appearance of the curtains and prevent the folds at the ends from inverting, an additional hook is added to 'pin' the outermost folds in place.

Dressing your curtains

3

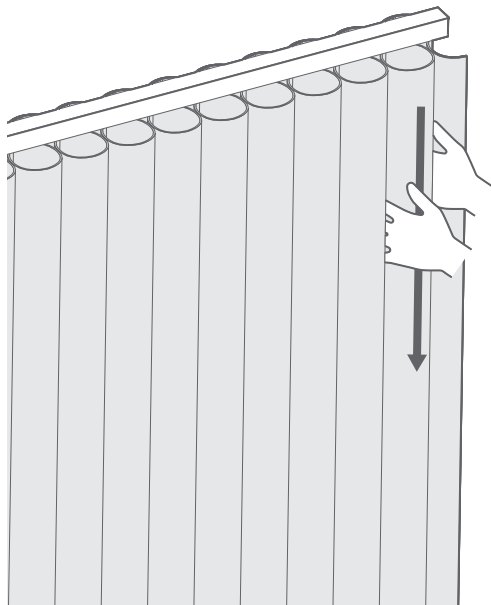

As curtains are a soft fabric product, a little dressing is sometimes required to finish the installation perfectly.

'Stack' the curtains over to the sides and check that the folds are all even in size and shape.

Starting from the outside edge, work from the top downwards and run your hands firmly down the length of each fold.

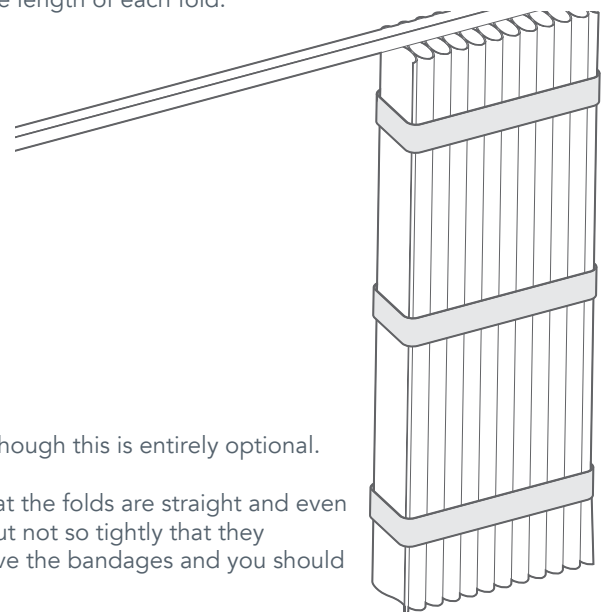

For a really professional finish, you can even 'bandage' the curtains, though this is entirely optional.

Wrap several runs of spare fabric around the curtains, making sure that the folds are straight and even as you do so - wrap them tightly enough to hold the folds in place, but not so tightly that they squeeze the fabric. Leave them bandaged for 2 or 3 days, then remove the bandages and you should find the folds are perfect.

Top-Tip:

When you first unpack your curtains they may be quite creased - this is normal, as they've been folded and packed for transit. These creases will hang out over time and we recommend leaving them to do so. If you have access to an upright steamer though, you can try lightly steaming the fabric (on a low setting) to encourage those creases to drop out faster.