

Fitting the brackets

1

The brackets offer two methods of installation:

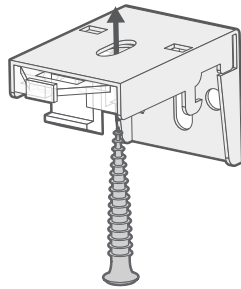

Top-Fixing

Use the single hole in the top of the bracket to fix to the lintel (the 'ceiling' of the recess).

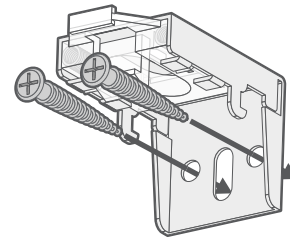

Face-Fixing

Use two screws through the back plate to mount onto a facing surface (a wall or window frame)



The outermost brackets should be mounted at least 5cm in from the ends of the blind. Any remaining brackets can be spaced evenly across the width of the blind.

Fitting the blind

2

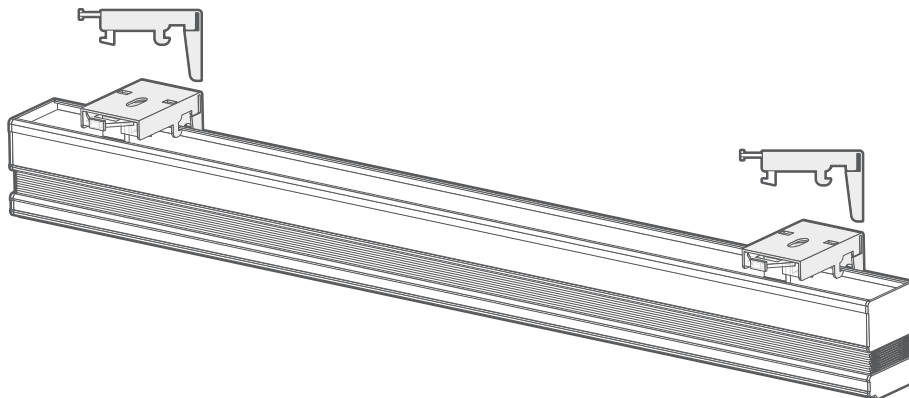

Align the rear inside lip of the headrail with the rear hook of the bracket.

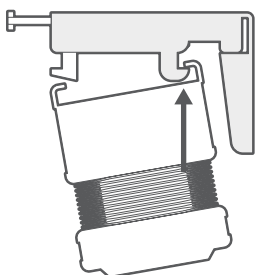

Push the protruding lever on the front of the bracket backwards.

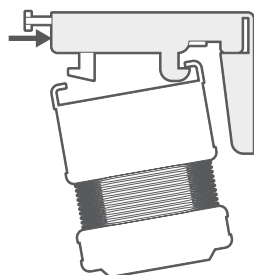

Tilt the headrail up until straight, then release the lever to lock in the blind.

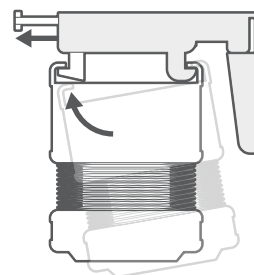

To release the blind from the brackets, push the lever back to release the front hook, then tilt the headrail downwards.

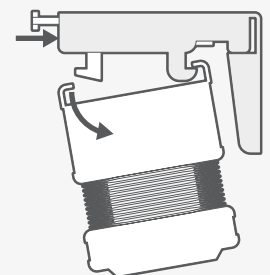

Child Safety

Cord Safety Cleat

The safety cleat shall be installed as close to the headrail as possible and in all cases not less than 1500mm from the floor. The cord must be fully accumulated around the safety cleat(s) when the blind is not in use. Use the table below to determine the distance required between the cleats to fully accumulate the cords when the blind is fully raised.

Mark the hole positions and drill as required. Use the screws provided to attach the safety cleat to the wall.

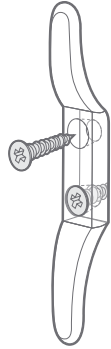

Wrap the cords around the cord cleats in a figure of 8. When the cords are fully accumulated, ensure they are secure so that when any cord is pulled, no excess cord is released.



Young children have died by wrapping loose curtain and blind cords or chains around their necks.



Secure cords or chains with cord guides or keep them out of reach by winding them around a cleat.

Move cots and furniture away from window covering cords or chains.

Do not remove this label.

WARNING: To avoid creating a possible strangulation hazard for children, the corded internal window covering must be installed in such a way that a loose cord cannot form a loop 220mm or longer at a height of less than 1600mm above floor level.