

Before you begin

The front roller blind is the highest and closest to you, so make sure that when marking the place where you will place the brackets, the rounded part of the bracket is pointing downwards.

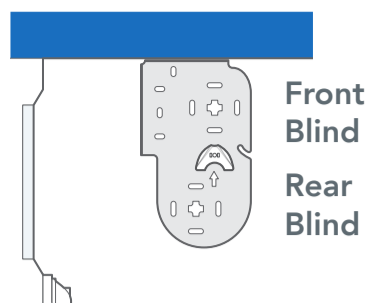

Fitting the brackets

1

The brackets offer three methods of installation:

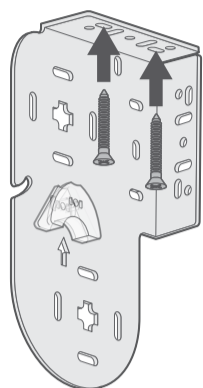

Top-Fixing

Where the brackets are screwed into the lintel (or 'ceiling' of the recess)

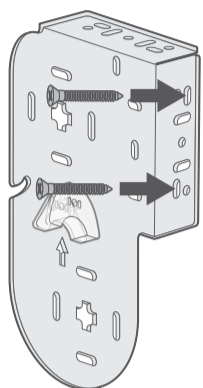

Face-Fixing

Where the brackets screw into a facing surface (a wall or window frame)

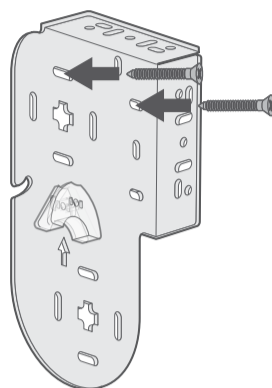

Side-Fixing

Where the brackets are screwed into the side walls of the recess

Top Tip



Top-fixing or face-fixing are recommended for most installations, whereas side-fixing is only recommended if the width you gave us was taken right at the top of the recess.

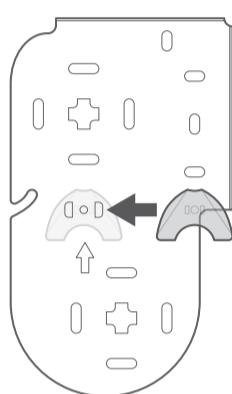

Control Side

On the control side, clip the chain runner attachment into the slot in the center of the bracket.

Fitting the blind

2

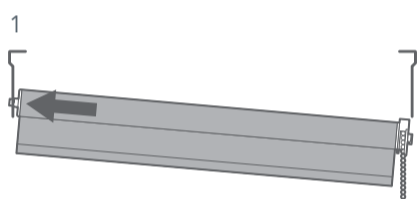

Install the rear blind first. Begin by placing the spring-loaded pin into the lower cross-shaped hole on the bracket. Push the blind toward the bracket so the spring-loaded pin depresses.

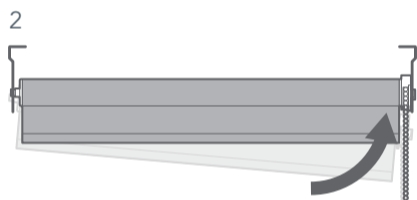

Keeping the pin depressed, lift the sidewinder end of the blind upwards so the blind is level and the chain is hanging directly down from the bottom of the sidewinder and slot the pegs of the control into the cross section of the bracket.

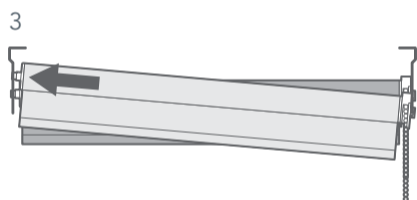

Repeat the process for the front blind placing the pin into the cross-shaped hole on the bracket and lifting the sidewinder side up to slot into the cross section.

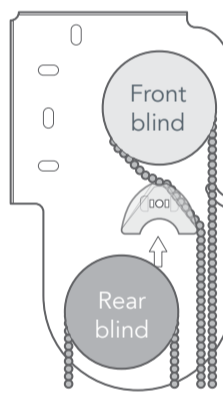
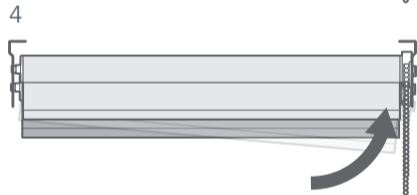

Take the chain for the top (front) blind and drape the back part of the chain over the chain runner so that the chain sits forward, preventing it from tangling with the other blind's chain.

Child Safety

3

Fitting the cord tensioner

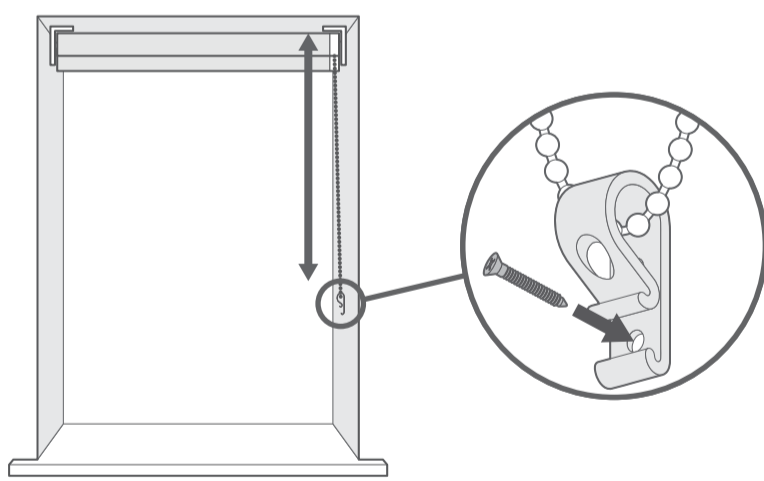

The cord retaining device must be installed at the maximum distance possible from the control mechanism to prevent looped cords from becoming slack.

Place the retaining device on the wall (one for each chain) and mark the position of the screw hole(s) with a pencil.

Attach the retaining device to the wall using the fixings provided.

Additional Information

Reverse rolling the fabric

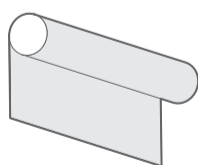

Standard

Roller blinds can have the fabric rolled onto the tube in two directions. The first is referred to as a 'standard' roll. This will place the fabric closest to the window or wall so that it comes down at the back of the tube. This is typically used with blackout blinds when they are mounted outside of a recess, the standard roll meaning that there is less light leakage.

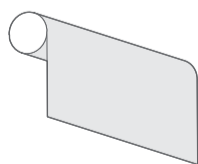

Reverse

The second method is referred to as a 'reverse' roll, which places the fabric so that it comes down at the front of the tube, effectively hiding the roll. This method will allow clearance behind the fabric, for window handles and other onstructions, if you're mounting the blind inside a recess.

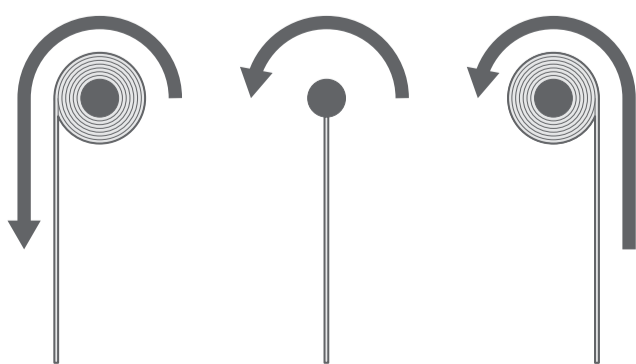

If you wish to change the roll method then it's easy; simply pull the back of the chain to lower the blind, and continue pulling until the metal tube is exposed. Keep going and the blind will begin to raise, with the fabric now pulling up over the front of the roller tube. Note that **this will reverse the direction you must pull the chain for raising and lowering the blind** (you'll now use the front of the chain to lower and the back of the chain to raise).