

Before you begin

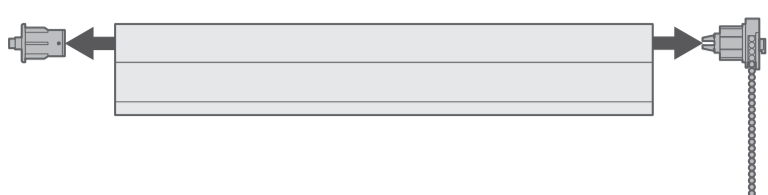

We will have positioned the controls where you requested during the ordering process. However if you decide to swap the side that they are on, direction of the roll or need to trim the blind further, the controls can be removed by simply unplugging them from the tube. This should be done prior to fixing the brackets.

Fitting the brackets

1

The brackets offer three methods of installation:

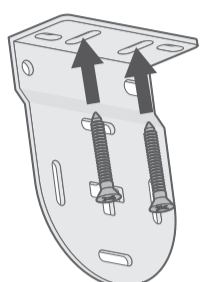

Top-Fixing

Where the brackets are screwed into the lintel (or 'ceiling' of the recess)

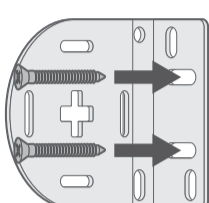

Face-Fixing

Where the brackets are screwed onto a facing surface (a wall or window frame)

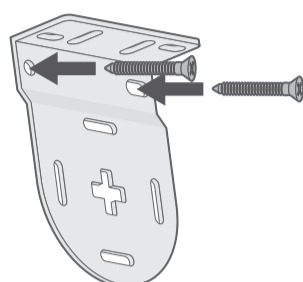

Side-Fixing

Where the brackets are screwed into the side walls of the recess

Top Tip

Top-fixing or face-fixing are recommended for most installations, whereas **side-fixing is only recommended if the width you gave us was taken right at the top of the recess.**



Fitting the blind

2

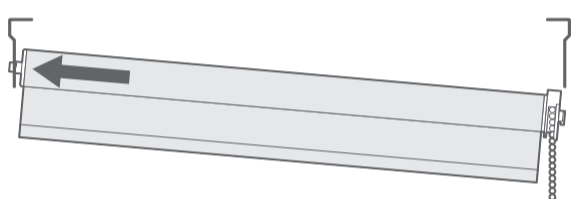

Locate the depression end (the opposite end to the controls) of the blind into the cross-shaped hole in the corresponding bracket.



Lift the control end of the blind and slot the rectangular 'lugs' into the corresponding slots on the bracket.

Child Safety

3

Fitting the cord tensioner

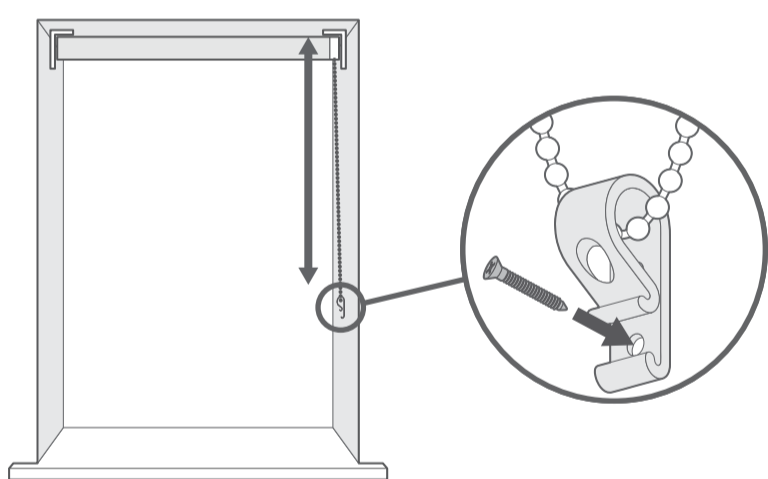

The cord retaining device must be installed at the maximum distance possible from the control mechanism to prevent looped cords from becoming slack.

Place the retaining device on the wall and mark the position of the screw hole(s) with a pencil.

Attach the retaining device to the wall using the fixings provided.

Additional Information

Reverse rolling the fabric

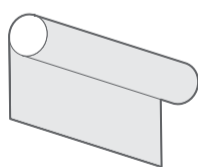

Standard

Roller blinds can have the fabric rolled onto the tube in two directions. The first is referred to as a 'standard' roll. This will place the fabric closest to the window or wall so that it comes down at the back of the tube. This is typically used with blackout blinds when they are mounted outside of a recess, the standard roll meaning that there is less light leakage.

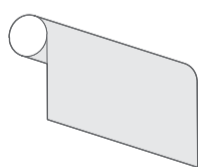

Reverse

The second method is referred to as a 'reverse' roll, which places the fabric so that it comes down at the front of the tube, effectively hiding the roll. This method will allow clearance behind the fabric, for window handles and other onstructions, if you're mounting the blind inside a recess.

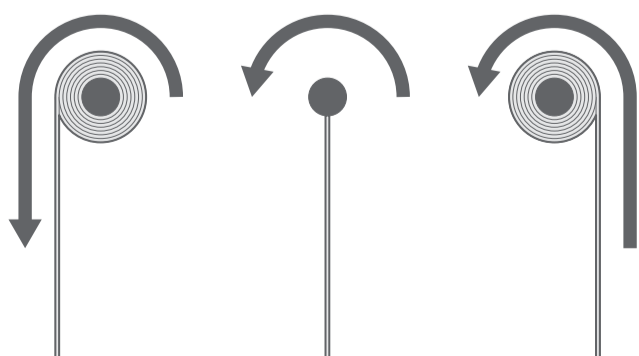

If you wish to change the roll method then it's easy; simply pull the back of the chain to lower the blind, and continue pulling until the metal tube is exposed. Keep going and the blind will begin to raise, with the fabric now rolling up over the front of the roller tube. Note that **this will reverse the direction you must pull the chain for raising and lowering the blind** (you'll now use the front of the chain to lower and the back of the chain to raise).